

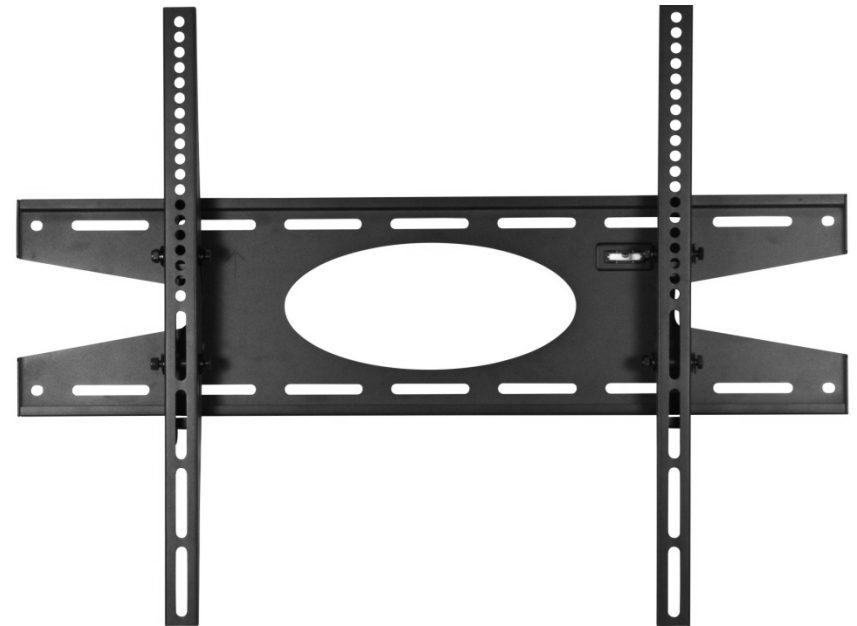

[www.revenaproducts.com](http://www.revenaproducts.com)

4915 SW Griffith Drive  
Suite 302  
Beaverton, OR 97005



Model  
VLS-TM5570

Universal Tilting Wall Mount  
for use with  
55" - 70" Flat Panel Displays

## Table of Contents

Warning and Caution Statements.....	1-2
Parts List .....	3-4
Installation Tools .....	4
Wood Stud Installation .....	5
Determining the Mounting Hardware .....	6
Attaching the Brackets to the TV.....	7
Attaching the TV/Brackets to the Wall Plate.....	8
Technical Specifications .....	9
Warranty .....	10

## Warning Statements

 Prior to the installation of this product, the installation instructions should be read and completely understood. The installation instructions must be read to prevent personal injury and property damage. Keep these installation instructions in an easily accessible location for future reference.

 REVENA does not warrant against damage caused by the use of any REVENA product for purposes other than those for which it was designed or damage caused by unauthorized attachments or modifications, and is not responsible for any damages, claims, demands, suits, actions or causes of action of whatever kind resulting from, arising out of or in any manner relating to any such use, attachments or modifications.

 Safety precautions must be taken at all times.

## REVENA LIMITED LIFETIME WARRANTY



### What and Who is Covered by this Limited Warranty and for How Long

REVENA warrants this product to be free from defects in material and workmanship for the lifetime of the original owner of this product. The limited warranty is valid only for the original purchaser of the product.

### What Revena Will Do

At the sole discretion of REVENA, we will repair or replace any product or product part that is deemed defective. If REVENA chooses to replace a defective product or part, a replacement product or part will be shipped to you at no charge, but you must pay any labor costs.

### What is Not Covered; Limitations

REVENA DISCLAIMS ANY LIABILITY FOR DAMAGE TO MOUNTS, ADAPTERS, DISPLAYS, PROJECTORS, OTHER PROPERTY, OR PERSONAL INJURY RESULTING, IN WHOLE OR IN PART, FROM IMPROPER INSTALLATION, MODIFICATION, USE OR MISUSE OF ITS PRODUCTS.

REVENA DISCLAIMS ALL OTHER WARRANTIES, EXPRESS OR IMPLIED, INCLUDING WARRANTIES OF MERCHANTABILITY AND FITNESS FOR A PARTICULAR PURPOSE. REVENA IS NOT RESPONSIBLE FOR INCIDENTAL OR CONSEQUENTIAL DAMAGES, INCLUDING BUT NOT LIMITED TO, INABILITY TO USE ITS PRODUCTS OR LABOR COSTS FOR REMOVING AND REPLACING DEFECTIVE PRODUCTS OR PARTS. SOME STATES DO NOT ALLOW THE EXCLUSION OR LIMITATION OF INCIDENTAL OR CONSEQUENTIAL DAMAGES, SO THE ABOVE LIMITATION OR EXCLUSION MAY NOT APPLY TO YOU.

### What Customers Must Do for Limited Warranty Service

If you discover a problem that you think may be covered by the warranty, you **MUST REPORT** it in writing to the address below within thirty (30) days. Proof of purchase (an original sales receipt) from the original consumer purchaser must accompany all warranty claims. Warranty claims must also include a description of the problem, the purchaser's name, address, and telephone number. General inquiries can be addressed to REVENA Customer Service at 1-866-3REVENA (1-866-373-8362). Warranty claims will not be accepted over the phone or by fax.

REVENA  
Attn: Warranty Claim  
4915 SW Griffith Drive  
Suite 302  
Beaverton, OR 97005

### How State Law Applies

THIS WARRANTY GIVES YOU SPECIFIC LEGAL RIGHTS, AND YOU MAY ALSO HAVE OTHER RIGHTS WHICH VARY FROM STATE TO STATE.

## Technical Specifications

### Front View

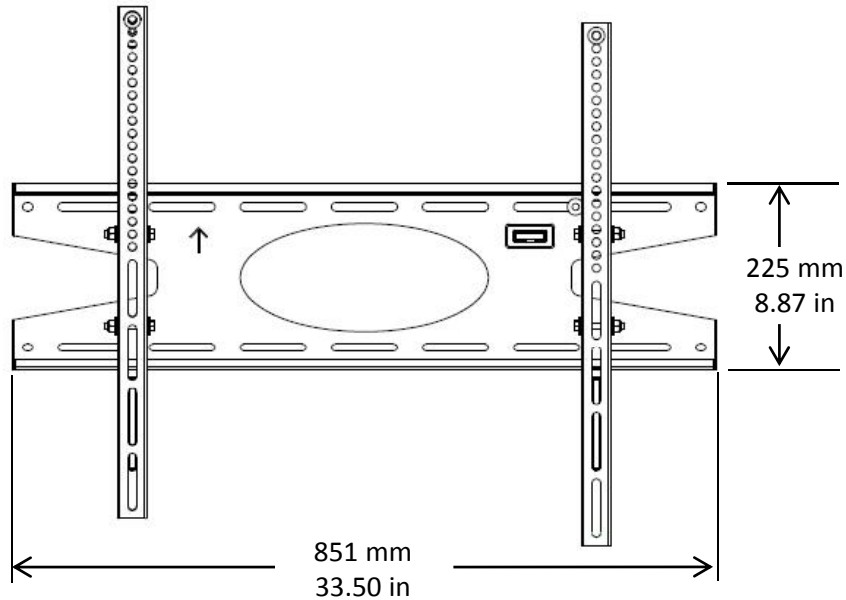

### Side View

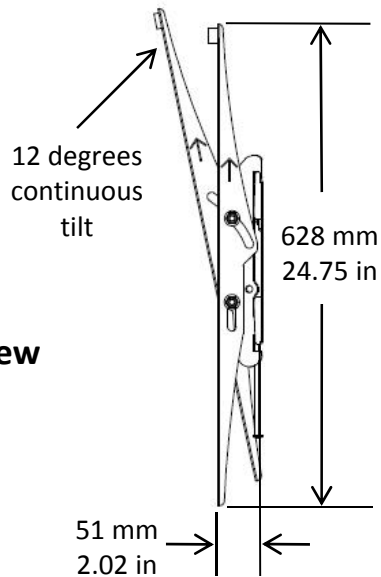

## Warning Statements

The surface must be capable of supporting at least five times the weight of the flat panel. If not, the mounting structure must be reinforced. The maximum weight that can be used with this product is 200 lbs.

Proper installation procedure by a qualified service technician, as outlined in the installation instructions, must be adhered to. Failure to do so could result in serious personal injury, or even death.

Safety measures must be practiced at all times during the assembly of this product. Use proper safety gear and tools for the assembly procedure to prevent personal injury.

## Caution Statements



It is recommended that a maximum of 5/8" plaster board be used when mounting to wooden studs.



Do not install on a surface that is prone to vibration, movement, or chance of impact. Failure to do so could result in damage to the flat panel and/or damage to the mounting surface.



Do not install near heater, fireplace, direct sunlight, air conditioning or any other source of direct heat energy. Failure to do so may result in damage to the flat panel and could increase the risk of fire.



At least two qualified people should perform the installation procedure. Injury and/or damage can result from dropping or mishandling the flat panel.

## Parts List

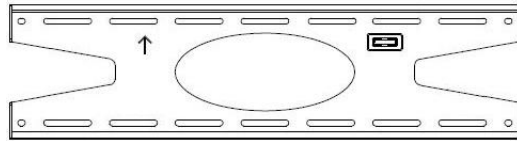

Congratulations on the purchase of your REVENA VLS-TM5570 flat panel mount. This mount is shipped to you with all the proper installation hardware and components. Make sure that none of these components are missing and/or damaged before beginning the installation process. If there are parts missing and/or damaged, please stop the installation process and contact REVENA at 1-866-3REVENA (1-866-373-8362).









Wall Plate (Qty 1)



Brackets (Qty 2)

-  M4x16mm combo head screw (Qty 4)
-  M4x25mm combo head screw (Qty 4)
-  M4x30mm combo head screw (Qty 4)
-  M5x16mm combo head screw (Qty 4)
-  M5x25mm combo head screw (Qty 4)
-  M5x30mm combo head screw (Qty 4)
-  M10x30mm combo head screw (Qty 4)

-  M6x16mm combo head screw (Qty 4)
-  M6x25mm combo head screw (Qty 4)
-  M6x30mm combo head screw (Qty 4)
-  M6x120mm combo head locking screw (Qty 2)
-  M8x16mm combo head screw (Qty 4)
-  M8x25mm combo head screw (Qty 4)
-  M8x30mm combo head screw (Qty 4)

## Attaching the TV/brackets to the wall plate.

 **Two people are required for this step.**

**Step 1.** To complete the final installation steps, two people should lift the TV and place the brackets over the upper and lower lip of the wall plate.

**Step 3.** Secure the mount in place by inserting the M6x120mm locking screws.

**Step 2.** Adjust your TV left to right on the wall plate.

 **Failure to fully tighten the locking screw may result in possible damage to your display.**

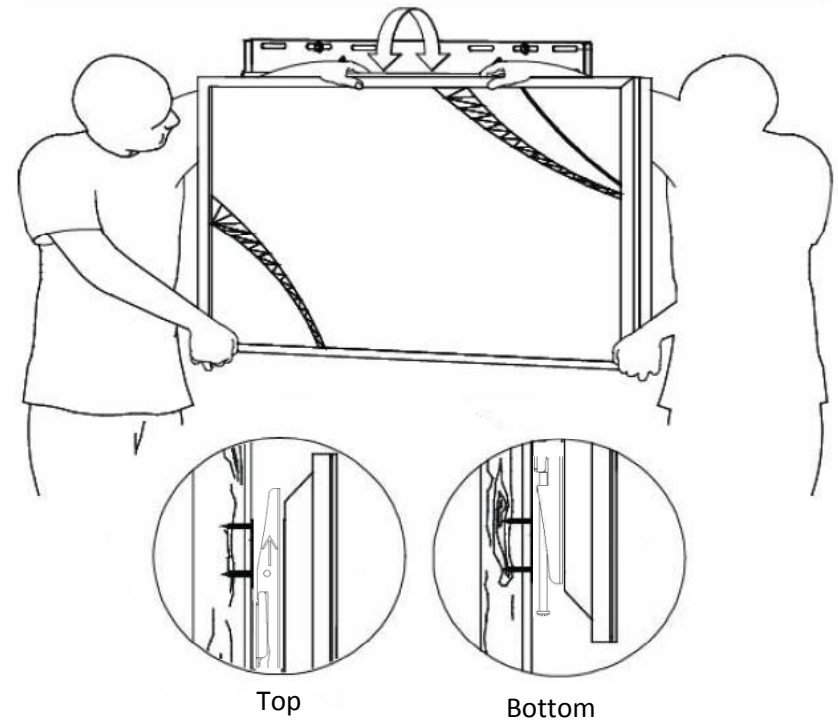

## Attaching the brackets to the TV

**i** You may not need any spacers for your TV.

**Step 1.** After determining the appropriate hardware, you are ready to attach the brackets to the TV.

**Step 2.** With the TV facedown on a flat/padded surface, lay the brackets on the back of the TV. Position each bracket so they are evenly spaced top to bottom.

**!** Do not over tighten the screws.

**i** If the back of your TV has a curved back, spacers must be used. If needed, place the spacers between the TV and the brackets.

**Step 3.** Use one (1) appropriate screw and one (1) universal washer per hole (see page 6).

**Step 4.** Tighten the screws down so that the brackets are secure.

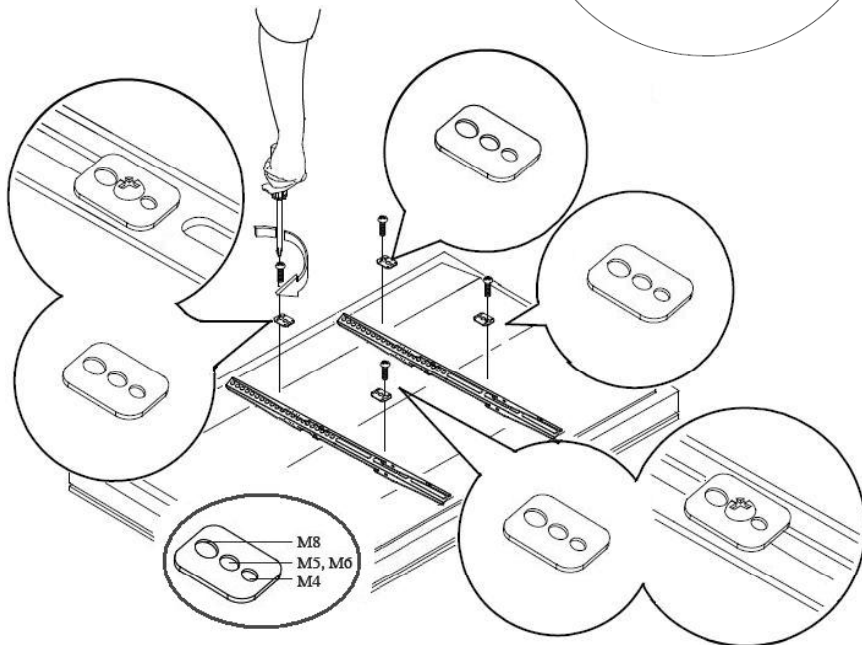
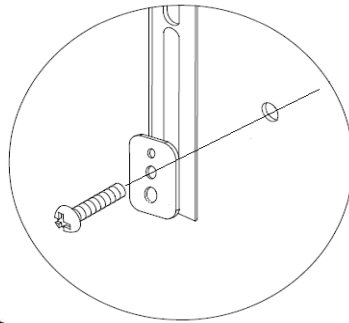

## Parts List



5/16 x 2.5" lag bolt  
(Qty 6)



5/16 x 2.5" flat washer  
(Qty 4)



Thread Depth Indicator  
(Qty 1)



Universal washer  
(Qty 4)



1/4" nylon spacer  
(Qty 8)



1/2" nylon spacer  
(Qty 12)

## Installation Tools Needed (Recommended):



Phillips head screw driver



Electronic stud finder



1/4" Drill bit

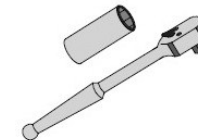

1/2" Socket and wrench



Portable drill

## Wood Stud Installation

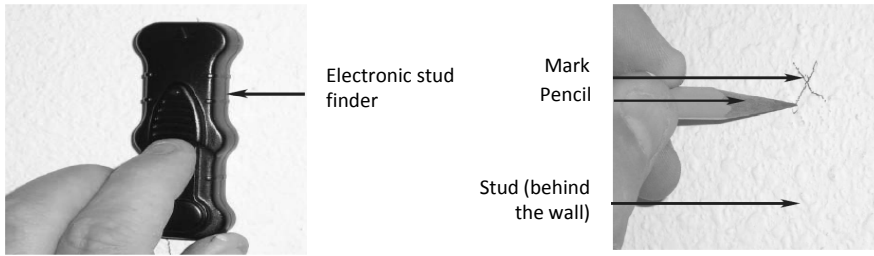

**Step 1.** Determine your mounting location.

**Step 2.** Use a stud finder to locate the nearest wall stud.

**Step 3.** Once the stud has been located, use a pencil to mark the center of the stud location.



This mark will be where the first pilot hole will be drilled. Center the wall plate on this mark.

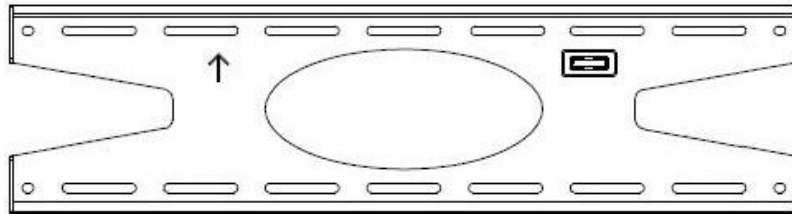

**Step 4.** Align the center of the wall plate to the appropriate viewing height. Once the desired viewing height has been determined, ensure the span of the wall plate is covering two studs.

**Step 5.** With the wall plate of the VLS-TM5570 in position, use a drill to pre-drill two (2) pilot holes with the 1/4" drill on the top row.

**Step 6.** Attach the wall plate to the wall using one (1) lag bolt and one (1) flat washer for each hole. Tighten down, but leave slightly loose for final leveling adjustments..

**Step 7.** Locate the marks for the lower holes on the stud and pre-drill two (2) pilot holes with the 1/4" drill on the bottom row. Use one (1) lag bolt and one (1) flat washer for each hole. Tighten down, but leave slightly loose for final leveling adjustments..

**Step 8.** With all four lag bolts and flat washers in place, make final leveling adjustments to the wall plate and tighten each lag bolt.

## Determining the Mounting Hardware

**Step 1.** Insert the Thread Depth Indicator (included) through the threaded hole on the back of your TV.

**Step 2.** Using a pencil, mark the depth of the thread insert on the Thread Depth Indicator .

**Step 3.** Compare and verify the depth of the remaining thread inserts.

**Step 4.** Locate the correct diameter screw for the thread insert.

**Step 5.** Compare your Thread Depth Indicator marking to the screw length.

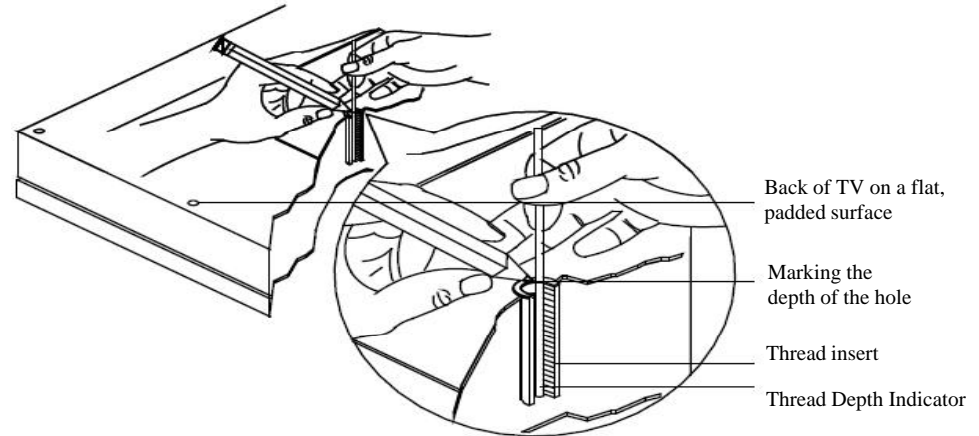

If you selected a screw that is longer than the marking on the thread depth indicator, do not use this screw. The screw length must not bypass the marking. If so, select another screw size until you find the screw that comes the closest to your mark without going past the marking.

